

SOME SEISMIC TECHNIQUES FOR MAPPING
SMALL SCALE SHALLOW STRUCTURES

by

Cornelius Joziasse

William M. Adams

Technical Report No. 11

August 1967

No. 3 of 5 Reports in Completion

of

GEOPHYSICAL EXPLORATION FOR HAWAIIAN GROUNDWATER, PHASE I

OWRR Project NO. B-005-HI, Grant Agreement No. 14-01-0001-1011

Principal Investigators: Leonard A. Palmer, Doak C. Cox, William M. Adams

Project Period: July 1, 1966 to June 30, 1967

The programs and activities described herein were supported in part by funds provided by the United States Department of the Interior as authorized under the Water Resources Act of 1964, Public Law 88-379.

ABSTRACT

Seismic recording and playback techniques and equipment are being developed for use in mapping small scale geologic structures of significance in controlling the movement of ground water. High-frequency seismic waves produced by weight-dropping, or thumping, are used to provide the necessary resolution to detect these small structures.

A vibrator has been constructed as another source of high frequency seismic energy. A DC motor is the transducer with storage batteries providing the power.

A four-channel tape recorder is used to obtain seismic records on a 10-foot spacing. This spacing gives good correlation from record to record.

A storage oscilloscope gives visual displays of seismic data as wiggly line playbacks which are stored on the screen and then photographed. Also being used is variable intensity playback of reflection records. This allows signal averaging to be done optically and gives an easily interpreted display.

A seismic survey done in the Waimanalo area on Oahu, Hawaii indicates that the thumper can produce sufficient amounts of high frequency energy to permit shallow reflection prospecting.

TABLE OF CONTENTS

LIST OF FIGURES.....	v
INTRODUCTION.....	1
PROCEDURES.....	1
Instrumentation.....	1
A. Thumping.....	1
B. Vibrator.....	3
Playback Techniques.....	4
Field Tests.....	9
RESULTS AND CONCLUSIONS.....	9
BIBLIOGRAPHY.....	13

LIST OF FIGURES

Figure

1	Recording System.....	2
2	Playback System.....	2
3	Vibrator.....	5
4	Vibrator Seismic System.....	6
5	Reflection Records - Kaneohe Ranch.....	8
6	Reflection Records - Waimanalo.....	8
7	Refraction Records - Waimanalo.....	9
8	Variable Density Reflection Record - Waimanalo.....	10
9	Location Map.....	12
10	Reversed Refraction Profile Travel Time Plots - Waimanalo.....	13

INTRODUCTION

The applicability of seismic techniques to the mapping of small scale structures in Hawaiian lava flows which could potentially act as reservoirs or channels for ground water was tested.

Originally three types of energy sources, *i.e.*, explosives, weight-dropping (thumping), and a vibratory source were considered. Because of practical difficulties in using explosives in an area as heavily populated as the island of Oahu, this method has been discontinued after preliminary experimental application. Developmental work is presently centered on the other two sources (Palmer, 1967).

Because of the anticipated small size of the structures, ten to one hundred feet, it is necessary to use higher than normal seismic frequencies to provide the necessary resolution. The sources of this high frequency energy and methods of presenting the data obtained using them are the concern of this study.

PROCEDURES

Instrumentation

A. Thumping

The major effort with the weight-dropping technique has been refinement of equipment and techniques of data recording (Fig. 1) and data playback (Fig. 2). All hardware associated with the dropping of the weight was completed prior to this year (Palmer, *op. cit.*). Field tests of new equipment and improvements to the available equipment were conducted at Waimanalo on the island of Oahu. A four-channel Crown Series 800 tape recorder with a greater data handling capacity than the two-channel Ampex recorder used previously was acquired. It is used both for data acquisition in the field and for playback.

The rate at which records are obtained when doing field work with the weight dropper is governed primarily by the rate at which the weight can be dropped. Since this is limited by the equipment currently used to raise and drop the weight, data acquisition rate can be raised only by increasing the

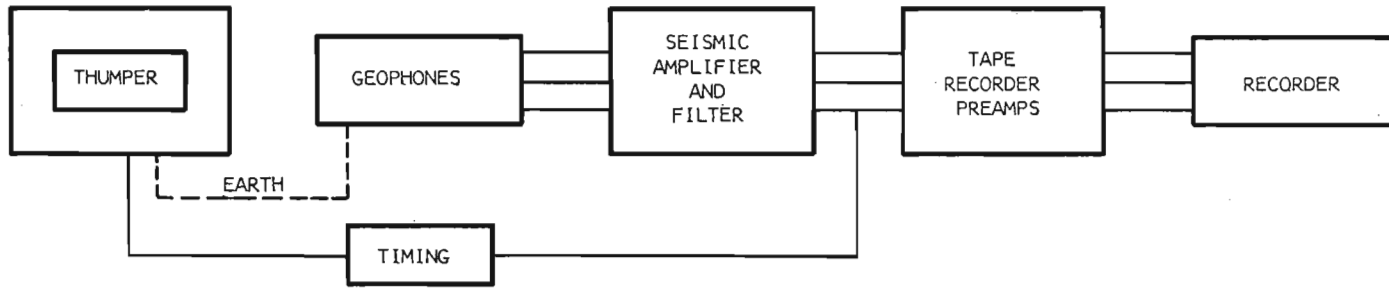

FIGURE 1. RECORDING SYSTEM

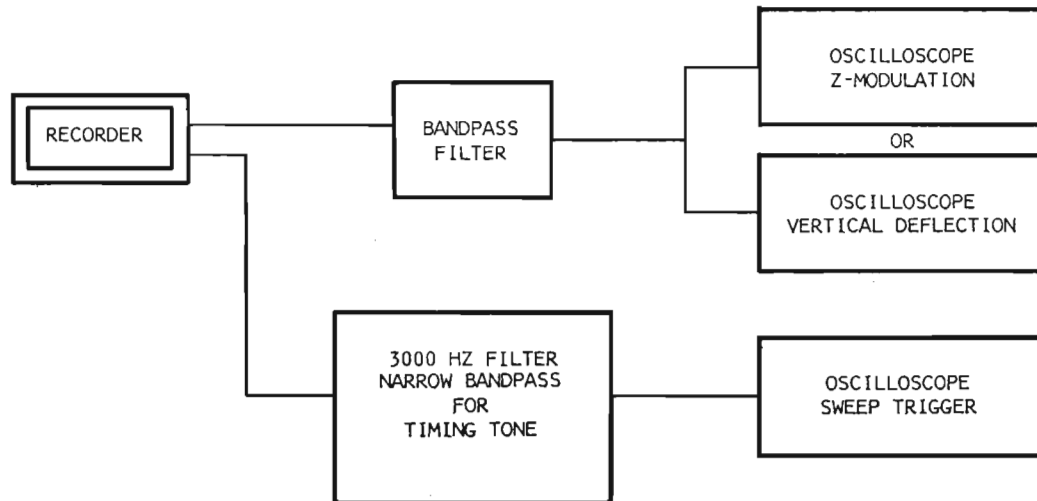

FIGURE 2. PLAYBACK SYSTEM

number of data recording channels. Only three data recording channels are available with the present equipment. A suitable filter to separate the 3000 Hz. timing signal from the seismic data will increase the present recording capacity to four channels by allowing timing and seismic data to be recorded on the same channel.

Although the amplifiers built into the tape recorder are sufficient to amplify the seismic signal to the full dynamic range of the tape, the data thus recorded have a poor signal-to-noise ratio because of a large amount of high frequency hum picked up from the inverter used to provide 60 Hz. power for the tape deck. Seismic amplifiers provide preliminary noise filtration and allow utilization of the full dynamic range of the tape to record seismic signals. Use of the seismic amplifier also extends the range of detectability of the signal.

The structures of interest to this study are on a scale of tens to hundreds of feet. To be able to resolve sufficient detail, it is necessary to use seismic frequencies of about 100 Hz. or higher rather than the more usual lower frequencies. These high frequencies used on the small scale structures studied can result in very rapid changes in wave-form, even when moving geophone and source only a short distance. Several field tests for optimum density of data show that correlation from trace to trace is best with drops taken every ten feet. A spacing of twenty feet often yielded records that were difficult to correlate with those of neighboring shots. A 5-foot interval did not produce any significant improvement over records obtained at 10-foot intervals. A study showed that irregular changes in wave-form may occur between two duplicated drops. Thus, when trying to correlate from record to record, it is important to remember that wave-form changes may be due to some variation in drop procedure rather than a geological change.

B. Vibrator

Weight-dropping is inherently a low frequency source of seismic energy. Neitzel (1958) shows that high-frequency energy content can be increased by increasing the velocity with which the weight hits the ground but the velocity can only be increased by a small amount. Signal averaging also acts as a low pass filter. Therefore, a source which puts high-frequency energy into the ground, an electromechanical vibrator, is being constructed. A swept

frequency signal is also being applied to the vibrator to utilize possibilities of cross-correlation of input and output offers (Fig. 3).

The vibrator is powered by a DC electric motor. Its torque is converted to rectilinear motion. Because of the large mechanical loads imposed on it, the armature rotates only imperceptibly and there are no difficulties with the high speed motion necessary for the anticipated frequency range of 50 to 500 Hz.

A swept-frequency signal, pre-recorded on tape, drives a power amplifier which supplies the power for the motor. The power amplifier will supply approximately 2000 watts to the motor from fifteen 12-volt storage batteries. The power input into the ground is undetermined. Preliminary tests with a 100-watt amplifier driving the motor gave good signal levels from geophones placed 25 feet from the vibrator.

The gain inherent in the cross-correlation process should extend this range further. For a given noise level, signal detectability is dependent on total signal energy, *i.e.*, that average power times the duration of the signal. In the vibrator system, power and signal detectability are increased by using a long swept frequency signal. Resolution in time is obtained by cross-correlating the input and output signals to produce a short pulse (Crawford, *et al.*, 1960). The amplitude of the pulse is proportional to $(\Delta \cdot T)^{\frac{1}{2}}$ where Δ is the bandwidth of frequencies present in the signal and, T is the duration of the reference signal (Klauder, *et al.*, 1960). The amplitude of the pulse and the gain of the system may thus be adjusted by varying the parameters Δ and T.

A block diagram of the vibrator seismic system is shown in Figure 4.

Playback Techniques

Because of the prohibitive cost of conventional seismic recording and display techniques, considerable effort has been directed to developing methods that can not only display seismic records conveniently, but are capable of handling large amounts of data. The latter requirement arises from the necessity of having data closely spaced to minimize random variations in waveform, effecting a statistical smoothing of the changes of waveform not due to changes in geological structure.

Wiggly-line records are made of both reflection and refraction records.

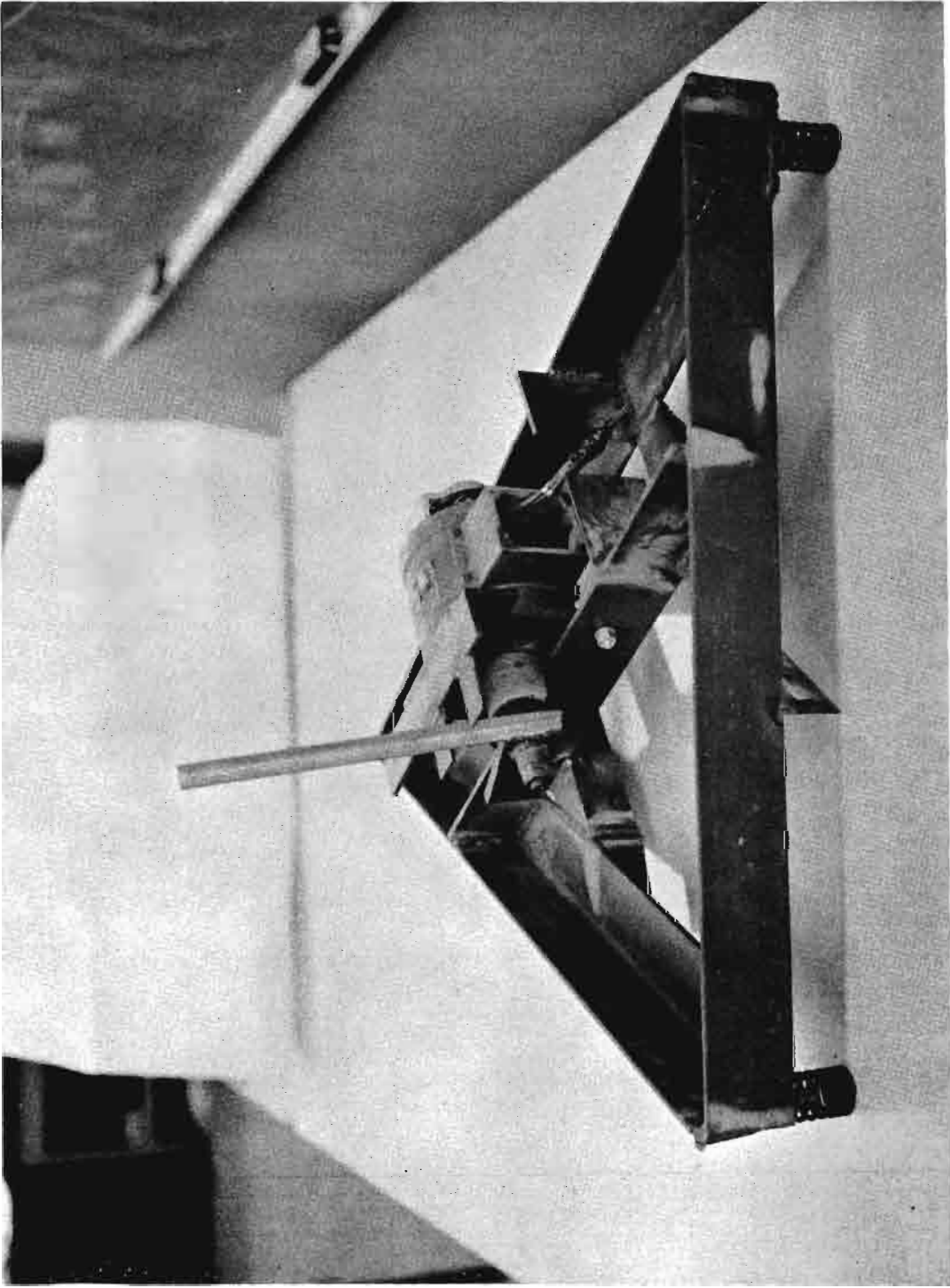

FIGURE 3. VIBRATOR

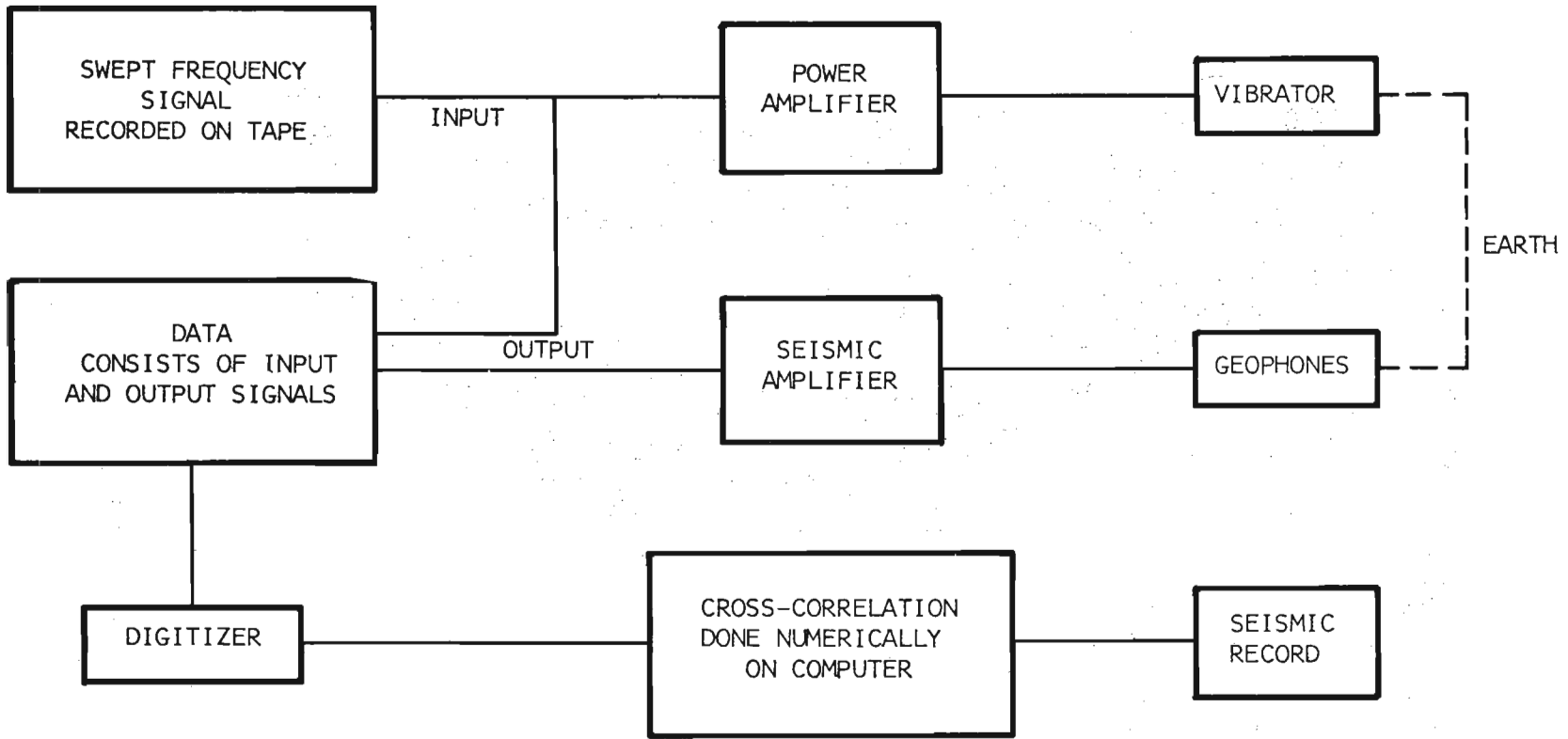

FIGURE 4. VIBRATOR SEISMIC SYSTEM

A Tektronix RM 564 storage oscilloscope, used in the playback center, gives wiggly-line playbacks of seismic records (Figs. 5, 6, 7). It allows the playback operator to receive an instantaneous visual display which can be studied to determine quality of the record and effects of various filter settings. Permanent records are made of all the useful results.

Variable intensity is another technique that is being used to display reflection records. The intensity of the oscilloscope trace is proportional to the wave amplitude. The intensity oscillates about a constant grey level so that large negative pulses are black and large positive pulses are white (Fig. 8). Usually the only input applied to the vertical deflection plates is a high-frequency signal used to make the trace wider. A variation, in which a wiggly line trace is intensity-modulated, has also been tried but this presentation was unsatisfactory because it gave redundant amplitude information and was more difficult to interpret than the variable intensity presentation in which the trace is not amplitude modulated.

The intensity-modulation is achieved on the oscilloscope by applying the filtered seismic signal to the z modulation input. The storage oscilloscope is not desirable for this work because in the storage mode there are only two levels of intensity with no gradation between them.

Permanent records are made on a polaroid oscilloscope camera using the vertical position control to move the oscilloscope trace. Initially, a motor driven 35-mm moving film oscilloscope camera, which advances film at a constant rate was used, but because the data are recorded at irregular intervals on tape, this system proved to be too complex.

The variable intensity method of presenting data lends itself readily to signal averaging. Averaging the results of repeated drops at the same location improves the signal-to-noise ratio by \sqrt{N} , where N is the number of drops. Since intensities add, the records can be averaged by playing all of them back over the same trace. This technique is superior to the originally selected method of digitizing the data and averaging values numerically in that the variable intensity method is less expensive and simpler.

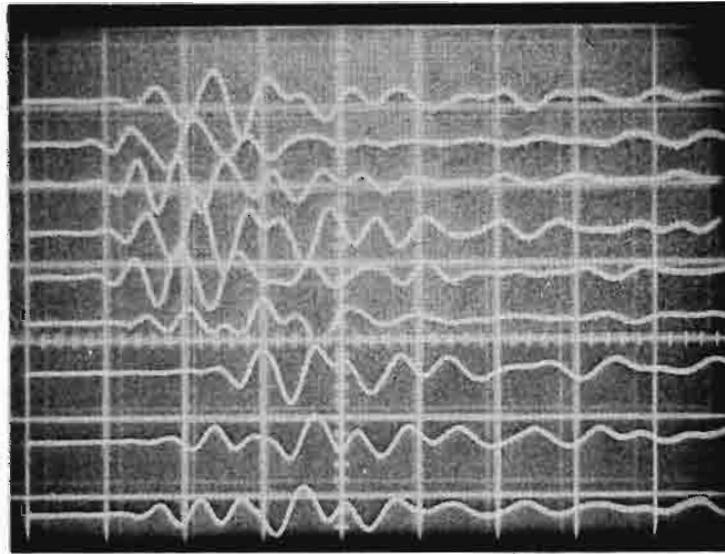

FIGURE 5. REFLECTION RECORDS - KANEOHE RANCH
FILTERED 50-100 Hz; 20 ms/div

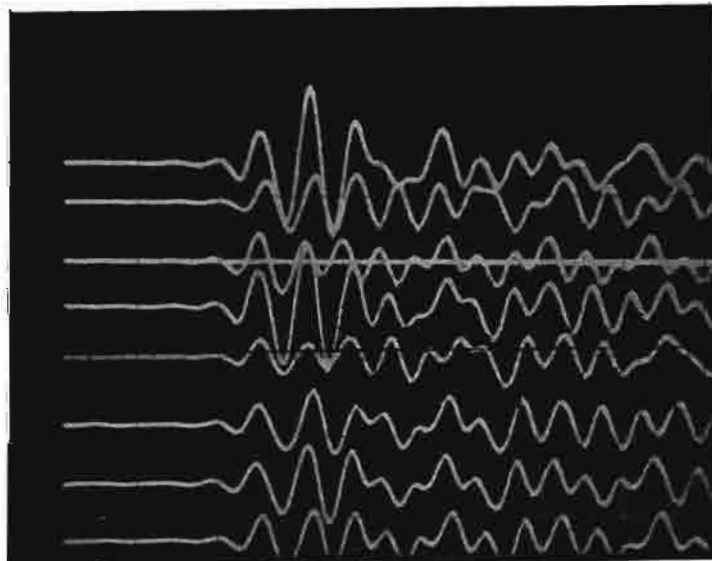

FIGURE 6. REFLECTION RECORDS - WAIMANALO
FILTERED 70-100 Hz; 20 ms/div

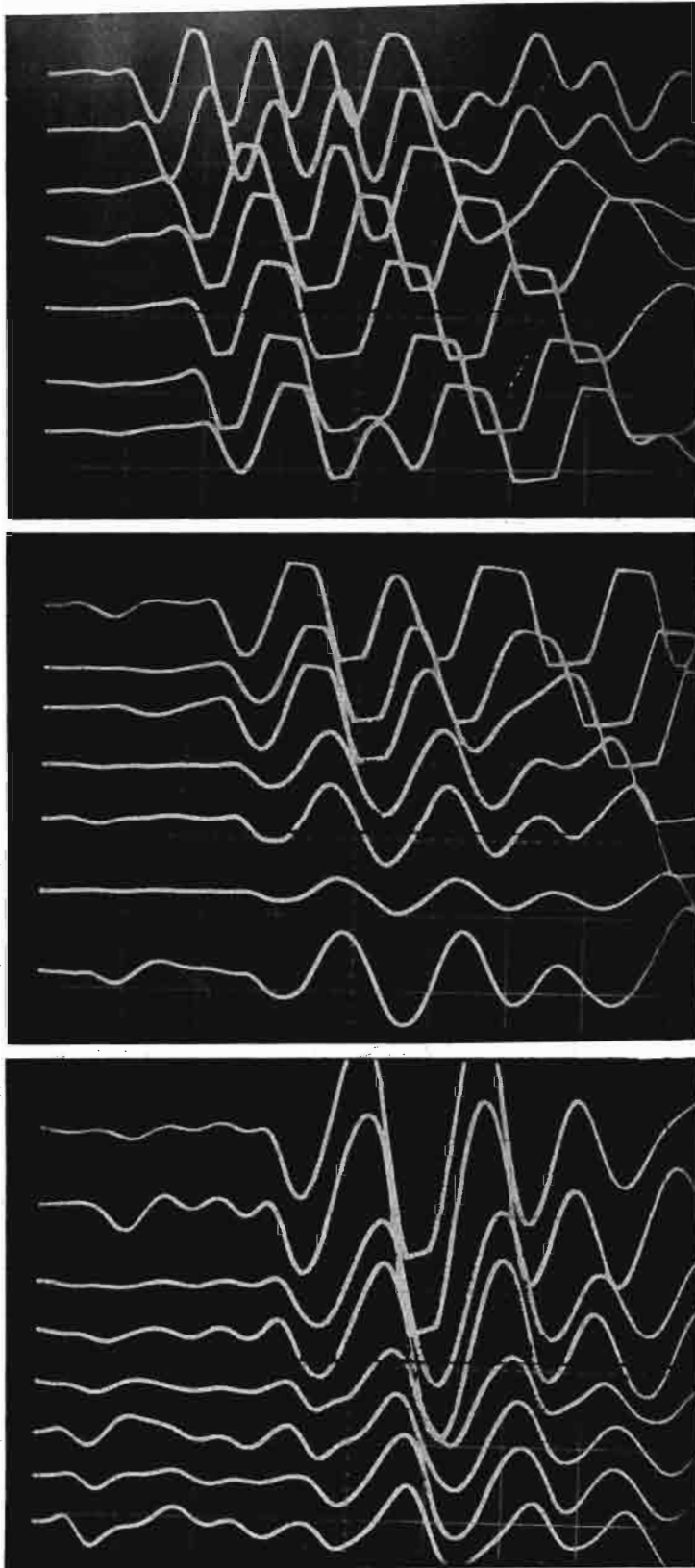

FIGURE 7. REFRACTION RECORDS - WAIMANALO
FILTERED 6-60 Hz; 20 ms/div

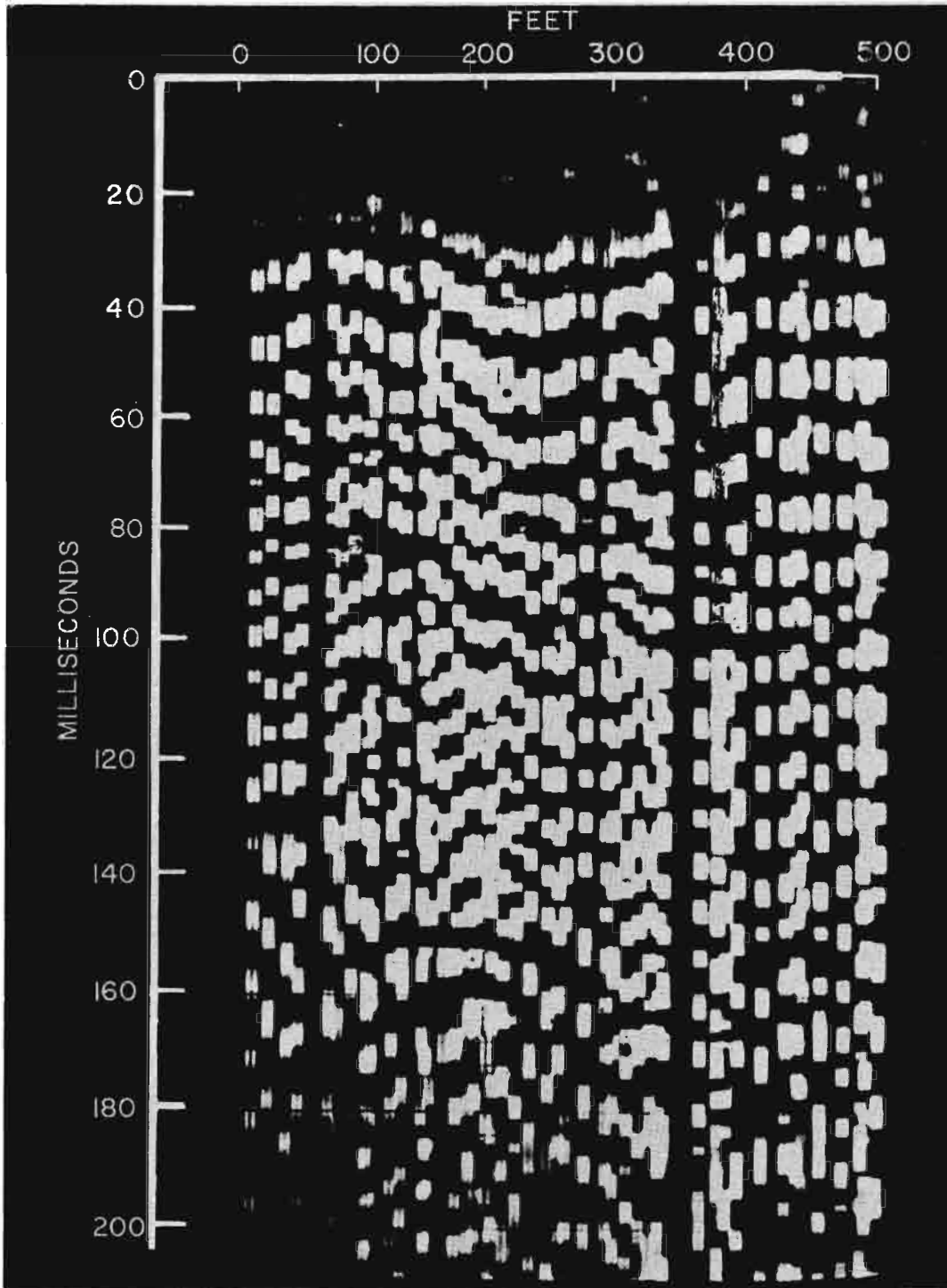

FIGURE 8. VARIABLE DENSITY REFLECTION RECORD - WAIMANALO

Field Tests

The techniques described were all tested during the past year in trials at various points on the island of Oahu. In an attempt to apply the techniques developed, more extensive data-gathering field tests were performed at Kaneohe Ranch and the Waimanalo Experimental Station of the University of Hawaii in windward Oahu (Fig. 9).

At Kaneohe Ranch there is a few feet of unconsolidated sediments overlying basalt flows from the old Koolau volcano. It was expected that these flows would show a steep dip. However, data obtained was erratic and unreliable for two reasons. A seismic amplifier was not used in this trial, resulting in records that were quite noisy, and the 20-foot spacing between records was too large for the complexity of the geology. An example of reflection data obtained is shown in Figure 5.

A decision was then made to test the weight-dropping method in an area of less complex geological structures. The Waimanalo Experimental Station appeared to be a suitable site, where a fairly thick sedimentary layer overlies the original basalt. Driller's logs from water wells in the area indicate there are some layers in the sediments which might be good reflectors at depths which can be investigated by the thumper.

The seismic survey was conducted along a 1600-foot line. Eight hundred feet were covered by two reversed refraction profiles, each four hundred feet long. The remaining eight hundred feet were covered by two single-ended refraction profiles. Five hundred feet at one end of the line was covered by a reflection survey. In all cases, records were obtained at ten feet intervals.

RESULTS AND CONCLUSIONS

The records obtained at Waimanalo were good. Some examples are given in Figures 6, 7, and 8. The interpretation of these records has not yet been completed. Preliminary travel time plots of first arrivals are shown in Figure 10.

The variable intensity record section (Fig. 8) shows an interesting event at approximately 160 ms. This event appears to have a relief of 18 ms. Using a rough estimate of velocity of 4000 ft./sec. this would

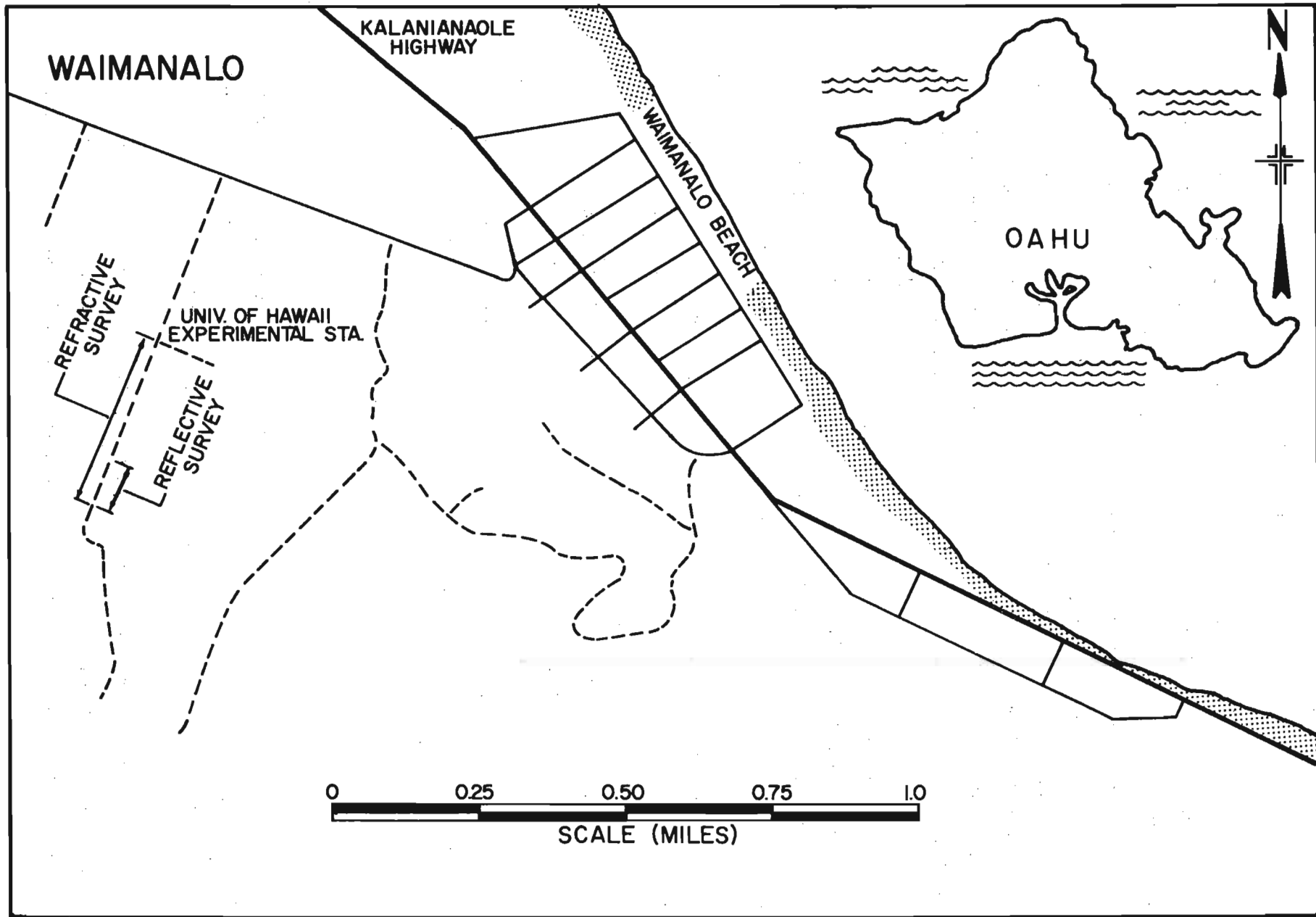

FIGURE 9: LOCATION MAP

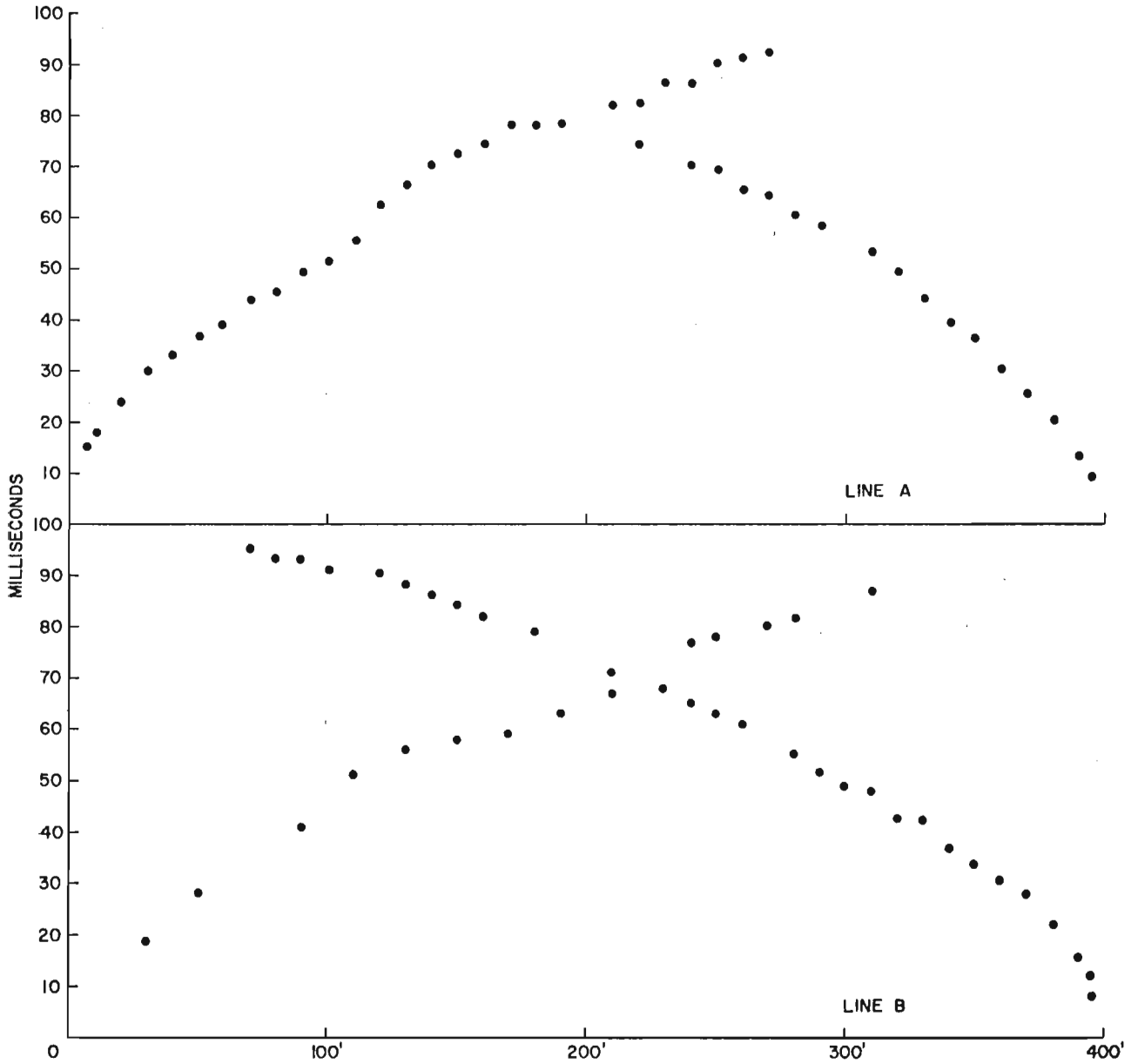

FIGURE 10. REVERSED REFRACTION PROFILE TRAVEL TIME PLOTS - WAIMANALO

indicate some structure at a depth of 300 feet which has a relief of about 30 feet. The reflection method thus has a penetration of at least 300 feet and sufficient resolving power to show relief in structures on the order of tens of feet. The refraction method was not as successful. Refracted signals can be consistently separated from noise with a shot-to-detector distance of only 250 feet. This would place an upper limit on the penetration at approximately 100 feet. To achieve this distance, it is necessary to use very low filter settings of less than 50 Hz. Attempting to gain more resolving power by using a higher frequency band leads to a great loss in penetration because the signal is attenuated very rapidly as the shot-to-detector distance is increased.

Optical signal averaging was attempted with some data gathered for that purpose. There were no conclusive results obtained from this experiment although the experiment did show that optical signal averaging is technically feasible.

It is significant that the reflection record section, which shows the structure, was passed through a band pass filter set at 100 to 200 Hz. Weight-dropping is primarily a low frequency source (Nietzel, 1958), but it appears that enough energy is produced in the higher seismic frequencies to map shallow structures. Using a lower passband would improve penetration, but at a cost of loss in resolution.

Although a closer study of the refraction records must still be made and the results correlated with the results of the reflection survey, preliminary examination of the records obtained indicated that the seismic weight-dropping technique can be applied to the mapping of small scale shallow geologic structures such as are of interest in ground water movement.

BIBLIOGRAPHY

- Crawford, J. M., Doty, W. E. N. and Lee, M. R., 1960, *Continuous Signal Seismograph*. Geophysics, February 1960, p. 95.
- Klauder, J. R., Price, A. C., Darlington S. and Albersteim, W. J., 1960, *The Theory and Design of Chirp Radars*. Bell System Technical Journal, July 1960, p. 745.
- Nietzel, E. B., 1958, *Seismic Reflection Records Obtained by Dropping a Weight*. Geophysics, V. 23. p. 58.
- Palmer, L. A., 1967, *Instrumentation for Seismic Exploration for Ground-water in Hawaii*. Water Resources Research Center, University of Hawaii (Honolulu), Tech. Rpt. No. 6. p. 26.