

POULTRY KEEPING FOR BEGINNERS IN HAWAII

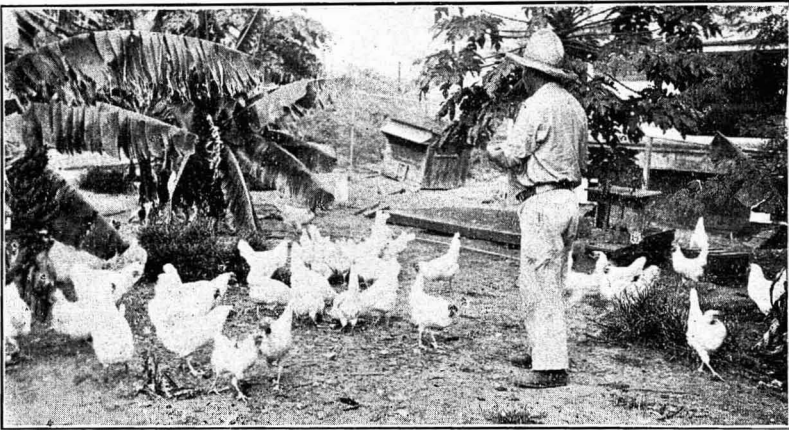

Agricultural Extension Service

University of Hawaii, Honolulu, T. H.

WILLIAM A. LLOYD, DEAN

Cooperative Extension Work in Agriculture and Home Economics, University of Hawaii and United States Department of Agriculture Cooperating.

Act of May 8 and June 30, 1914.

UNIVERSITY OF HAWAII

DAVID L. CRAWFORD

President

STAFF
AGRICULTURAL EXTENSION
SERVICE

William A. LloydDean
Gladys M. WoodAdministrative Assistant

AGRICULTURE—

Frederick G. KraussAssistant Director
Theodore C. ZschokkeExtension Forester
Hung Lum Chung Extension Animal Husbandman
Robert Pahau Extension Sugar Technologist

County Extension Agents (Farm)

Hong Chang WongHonolulu County
Roy A. GoffHawaii County
Yasuo Baron GotoHawaii County
John C. ThompsonKauai County
Clifford C. DavisMaui County

HOME ECONOMICS—

M. Elmina WhiteAssistant Director

County Extension Agents (Home)

Mabel GreeneHonolulu County
J. Hazel ZimmermanHawaii County
Martha L. EderKauai County
Gertrude M. GageMaui County

CONTENTS

	Page
Introduction	1
Possibilities of a home flock	1
Making a start	2
Producing eggs without yards	2
Rooster not necessary	3
Breeds and breed selection	3
Size of home flock	4
Obtaining the stock	4
Locating the poultry house	6
Drafts	6
Fencing	6
Poultry house for layers	6
Roof	8
Floor	8
Roost	10
Dropping boards	10
Nests	10
Feeds and feeding	10
Feed containers	12
Table scraps	12
Green feed	12
Minerals	12
Water	12
Changing feed	13
Incubating eggs	13
Hatching season	13
Breeding stock	13
Care of hatching eggs	13
Inducing hens to set	13
Setting and care of broody hens	13
Testing the eggs	14
Hatching time	16
Chick feeds	17
Feeding the chicks	17
Weaning the chicks	18
Fattening cockerels	18
Feed for pullets	19
Ailments of chicks	20
How to treat new birds	21
Care of imported birds	21
Care of the laying flock	21
Providing shade	21
Replacing layers	21
Laying period	21
Keep roosting quarters clean	22
Disposing of litter and manure	22
Broody hens	22
Culling	23
Ailments of adult birds	23
Preserving eggs	24
Marketing	24

POULTRY KEEPING FOR BEGINNERS IN HAWAII

by

H. L. CHUNG

Extension Animal Husbandman

This bulletin is prepared expressly for those who are planning to maintain a home flock. The instructions are simple and with the object of showing a way to start the backyard venture with a minimum cost and accomplish the beginner's desire to obtain experience while deriving pleasure and ultimate profit.

Possibilities of Home Flock

The backyard poultry flock, besides furnishing eggs and meat for the home and experience and pleasure to a beginner, offers an unusual opportunity for poultry raisers to establish new egg records at the Hawaii annual egg-laying contests conducted by the University of Hawaii. The past six consecutive egg-laying contests have indicated that four out of the six annual contest winners were home flock owners. Likewise the highest individual record hens were mostly owned by the same group.

An idea of what a hen in Hawaii is capable of doing in the way of egg production is timely in this bulletin for the information of the beginners.

During the past five years the local stock of the different breeds has been brought up to such a high standard that it would not be difficult for any beginner to have the White Leghorn or Black Minorca stock from some reliable source produce fourteen dozen eggs, and the Barred Rocks, Rhode Island Reds, Wyandottes produce eleven dozen per hen per year. With more experience acquired the beginner will obtain better records from the same quality of birds.

The following table will give a better idea of the capabilities of the Island-bred birds, as indicated in the past egg-laying contest held at the University of Hawaii. Most of the record hens and individual hens were owned by backyard poultry raisers:

Year	OWNERS	Total-5 Av. Per		OWNERS of highest hen	Record
		Layers	Hen		
1923	<u>Mrs. J. S. Donaghho</u>	1143	228	<u>Mrs. J. S. Donaghho</u>	262
1924	<u>Mrs. Y. W. Ow</u>	1147	229	<u>Mrs. Y. W. Ow</u>	265
1925	<u>L. K. Smith</u>	1245	249	<u>L. K. Smith</u>	272
1926	<u>Wm. Cluney</u>	1206	241	<u>Dan Pokipala</u>	286
1927	<u>Kewalo Farm</u>	1173	234	<u>Alfred Correia</u>	296
1928	<u>H. B. Pogue</u>	1088	217	<u>Kamehameha School</u>	247

NOTE—The names underscored are backyard flock owners.

Making A Start

The natural question asked, in connection with backyard poultry keeping is "What is the best way for a beginner to start?"

There are four ways to start a poultry flock:

1. Incubation of hatching eggs.
2. Purchase of day-old chicks.
3. Purchase of matured layers.
4. Purchase of eight to ten-weeks-old pullets.

The choice of any one of the five or a combination of two will depend on the amount of space available in the backyard, the prospective poultry raiser's time, the facilities and the funds available. However, any one of the five has its advantages. But under ordinary conditions in Hawaii the poultry beginner will derive the most benefits in the venture, both in experience and pleasure, if laying or breeding stocks are purchased. Birds from either of the latter stocks do not require as much care and are less subjected to sickness than chicks raised artificially by the amateur without any practical knowledge of brooding.

Producing Eggs Without Yards

To a beginner the impression, after seeing so many birds in the open, is that a yard is essential for poultry raising. This is only true in so far as breeding for hatching eggs is concerned. When table eggs are the objective the layers may be confined without any loss in egg production. The poultry farm of the University of Hawaii recently conducted an experiment to substantiate this fact. In substance the result of the experiment indicated that the layers that were confined in a poultry house produced a slightly greater number of eggs per hen than the birds that were given free range. There were over 140 layers in each lot used for the test.

If, for some reason, the home flock must be confined in the poultry house the entire year, a definite knowledge of floor space for a given size flock of a certain breed is desirable.

As a general rule a home flock when confined should be given large floor space per bird in a small flock. The following table is a practical guide on area for the egg and general or dual purpose fowl and meat birds when confined:

For Flock of	Sq. ft. per bird	
	Egg breeds	General purposes
10	10	12
20	8	10
30	6	8
40	5	7
50 or over	4	6

From the above table one may determine the number of birds that can be kept comfortably confined in a poultry house on the premises or may build one of the proper size to accommodate the number of layers desired.

Rooster Not Necessary

Another question often asked is whether a rooster is necessary in a flock. The male is only necessary if the eggs produced are desired for hatching purposes; otherwise the layers will get along far better without the presence of the rooster. They will lay just as many eggs if not more. In a neighborhood where the houses are near each other the owner of a flock of chickens without a rooster, will get along much better with the neighbors who do not raise fowls. The crowing of the male at an early hour and throughout the day is usually very annoying. So in raising a home flock it would be well if the matter be considered from this angle and decide whether it be just for table eggs or hatching eggs.

Breed and Breed Selection

The breeds of chickens are generally divided into four groups according to purpose:

1. Egg
2. Meat
3. General purpose or utility
4. Exhibition or show

There are many breeds represented in each of the above groups, but mention will be given only to those breeds which have proven themselves to be satisfactory for Hawaiian conditions.

The breeds that are kept primarily for eggs are White Leghorn and Black Minorca. A good flock of either should average 180 eggs per hen per year in Hawaii.

The meat birds are represented by the Cornish, Brahmas, and Jersey giants. It would be advantageous, however, for a beginner to leave this class alone for the present.

The general utility fowls, which are intended for both meat and eggs, are the well known Plymouth Rocks, Rhode Island Reds, and Silver-laced or White Wyandottes. These breeds lay from 163 to 195 eggs per hen per year according to Hawaii's contest records.

The fancy group of birds is made up of the egg, meat and utility groups. It stands out as a distinct class because the birds are bred and selected for poultry shows purposely by amateurs and professional poultrymen. If fancy poultry raising becomes an interesting hobby to the beginner later he should get acquainted with an illustrated poultry text book, "The Standard of Perfection", (latest edition 1924), this is issued by the Ameri-

can Poultry Association, an organization composed mostly of America's foremost poultry fanciers, and may be borrowed from any public library. Keep in mind that some of the most successful poultrymen were at one time backyard poultry keepers themselves.

No matter what purpose the beginner may have in mind for his backyard poultry venture, choose one of the purebred fowls. A flock of such birds is always a pleasant sight to the owner and visitors because of its uniform shape, size and color.

As a rule it is difficult for a beginner to decide on the breed or variety of chicken to keep. This is because of the different claims made by other poultry owners with their respective breeds. These claims are so varied that it tends to influence the beginner to raise every breed and variety recommended. Another reason why it is somewhat difficult for a beginner to decide on a breed is his preference for certain characteristics of the fowl to suit his fancy. It may be the color or the shape of the fowl which will appeal to his taste.

Because of the difficulty encountered in deciding on a breed it is suggested that the beginner get acquainted with a group of poultry owners and learn what they are doing with their respective breeds and to what purpose they are best adapted. After deciding upon the breed locate a reliable breeder who will be able to furnish you the stock.

Size of Home Flock

The tendency of a poultry beginner is to increase his flock as soon as possible. This is a mistake.

If matured stock is purchased, from six to twelve will be about the average number that should be kept by a beginner. However, if the yard space is large and funds are available for more adult birds he may manage a larger number provided thirty square feet of yard space is allowed each bird.

Should hen-brooded chicks be raised to produce future layers for the home flock, allowance must be made for the expected 10% mortality and the regular proportion of 50% cockerels and 50% pullets in the brood. The accepted practice is to figure three eggs set for each pullet desired at laying age. The mortality will decrease as more experience is acquired. Thus if fifteen pullets are desired from the broody hens it will be necessary to set sixty eggs to get that number of pullets for a given yard area.

Obtaining the Stock

Whether the purpose is for laying or breeding, get the best birds or eggs from a reliable breeder. Do not make the fatal mistake of buying from some unknown source because the stock is cheap. Have the county Extension Agent assist you in obtaining a right start. He will be able to give you the names and addresses of breeders nearest to the purchaser's home town or elsewhere

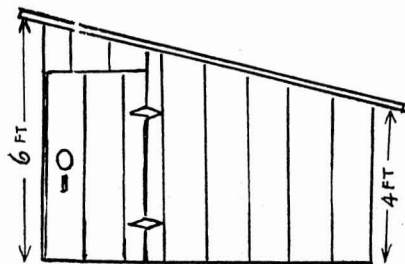

FIGURE 1

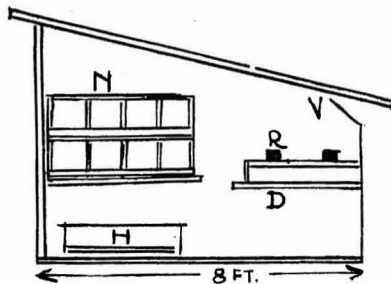

FIGURE 2

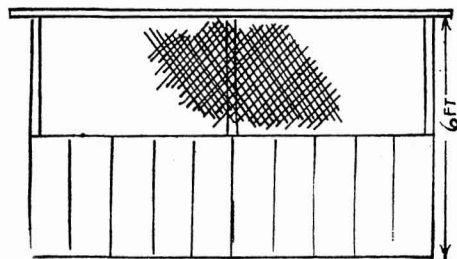

FIGURE 3

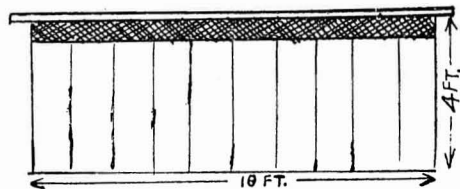

FIGURE 4

Fig. 1—Side elevation of a shed-roof poultry house.

Fig. 2—Interior side-view showing the arrangement of the ventilation in the rear, nests, mash hopper, roosts and dropping boards.

Fig. 3—Front elevation of shed-roof poultry house. The upper half is screened with one-inch wire netting.

Fig. 4—Rear elevation of the poultry house showing the upper four inch of the back is opened and screened with one-inch wire netting.

in the territory if requested. His address will be found elsewhere in this bulletin.

When plans are made to buy stock, it is well to have the breeder furnish the desired number of birds at a certain age for a stated sum. This plan will work out to the mutual benefit of the seller and buyer.

Locating the Poultry House

The backyard poultry raiser has little choice of location for the poultry house if the backyard space is limited. Whatever space is available for the poultry venture it has to be used to the best advantage.

Where it is possible to do so, locate the poultry house site somewhere in the yard so that fresh air and sunlight will not be shut off by trees, shrubs, or other buildings on the place. If the yard shows a tendency to be damp, a layer of coral rocks added to the surface will materially improve the condition.

In building the poultry house face the opening with the direction of the prevailing winds, i.e., the back of the building is facing directly opposite the direction of the wind. If the yard is large and it is in the open, several rows of pigeon peas planted around the yard, especially back of the poultry house, will make a valuable asset to the premises and later serve as a shade for the flock.

Drafts

There must be no drafts in a poultry house, i.e., the wind should not, under any circumstance, hit the birds directly from any part of the building to which the birds have access. This is especially true with the opening above the roost. If the ventilator is low and too near to the roost have a piece of 1 x 12 board to direct the wind upward as shown on page 7, figure 2-v.

Fencing

Two-inch mesh wire netting six feet high will answer the purpose for fencing. This material can be obtained from any hardware store either in rolls of 150 feet or in smaller quantity as needed. The Leghorns are apt to fly over the six foot fence, but by clipping the ten last flight or long, stiff feathers (not the tip) of each wing, the trouble will be eliminated.

Poultry House for Layers

The poultry house is an expensive thing in a poultry venture, but fortunately a home flock need not overburden the owner with an elaborate structure. A simple poultry house can be built adjoining another building as shown on page 8, figure 8, with the entire front covered only with poultry wire or with the lower half covered with lumber.

The kind and size of poultry house to build for the layers will

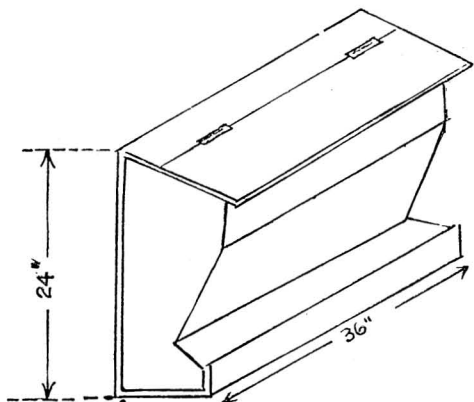

FIGURE 5

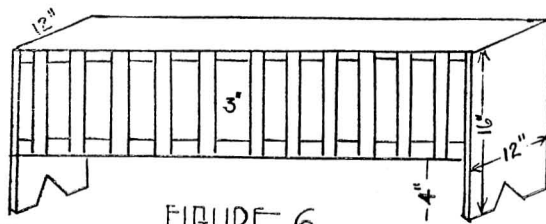

FIGURE 6

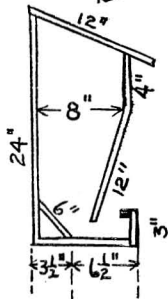

FIGURE 7

Agricultural Extension Service
 County Extension Work
 UNIVERSITY OF HAWAII
 United States Department of Agriculture
 Cooperating

Fig. 5—Mash hopper.

Fig. 6—Feed trough suitable for grain or mash feeds.

Fig. 7—Side view of the mash hopper showing the construction.

depend on the size of the yard, the breed and the number of layers desired. A large number of the successful backyard poultry raisers in Hawaii use piano or large packing boxes for poultry houses. (See page 9, figure 9 & 10.)

What is most desirable in a poultry house is comfort for the hens and convenience for the poultry raiser himself. A hen becomes a contented bird and will lay oftener if she is comfortable. The work about the poultry house is a pleasure if everything is orderly and convenient for the operator. Drawings and photographs of the poultry houses and interior arrangement are shown on page 5, figures 1, 2, 3 & 4. They will give the beginner an idea how they should be built and arranged.

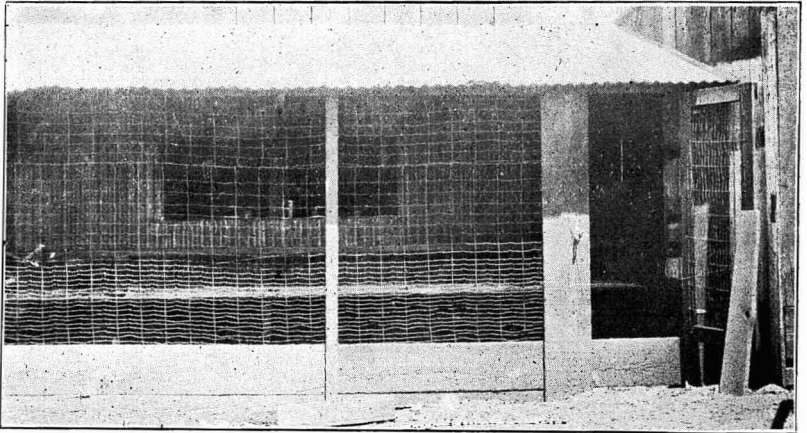

Fig. 8—A cheap and serviceable shed-roof poultry house built adjoining another building on the premises. (Photograph courtesy Hawaii Experiment Station)

Roof

Use the 2-ply roofing paper; it will serve the purpose for a regular-built poultry house or one out of a packing box. The main precautions to take before setting and nailing down the roofing paper is to see that the roof surface is free from protruding nails, and to have the paper overlap at least three inches to keep out the rain.

Floor

A poultry house floor is usually of earth, wood or concrete. A dirt floor is cheap but not desirable because it entails labor in the removing of surface soil periodically and replacing it with a fresh supply. But the principal objection to the use of dirt floors is the menace from rats. These rodents eat the feed and burrow holes under the dirt floor. Use dirt floors only as a last resort.

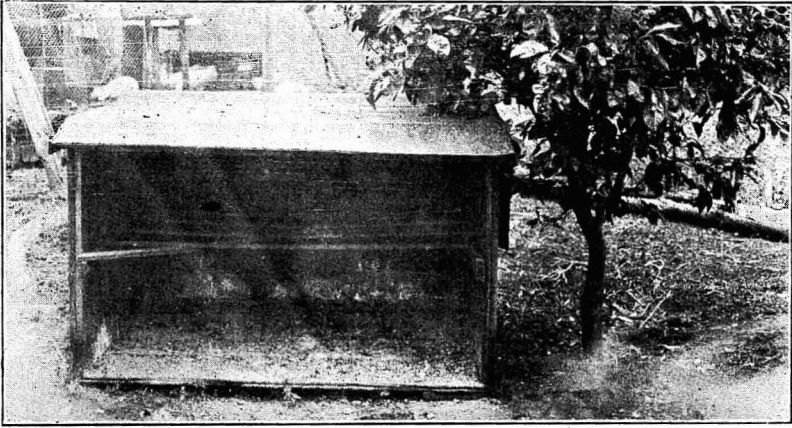

Fig. 9—Roosting quarters made from a large packing box for a few hens or growing stock. (Photograph courtesy Hawaii Experiment Station)

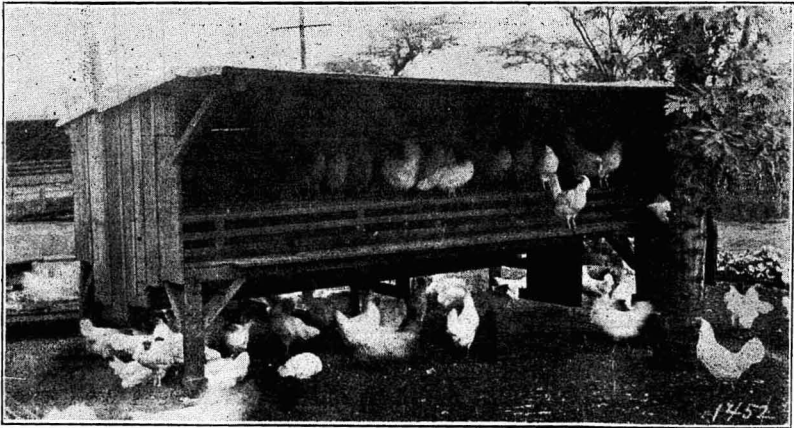

Fig. 10—Another simple poultry house made from packing lumber. The entire open front is very well adapted to the warm regions in Hawaii. (Photograph courtesy of Hawaii Experiment Station)

If a wooden floor is used, have it twelve inches or more from the ground, as this will prevent the rats from harboring near a poultry house.

The concrete floor is the best if it is certain the poultry house is a permanent structure; otherwise it would be impractical to make such an investment.

When the floor is ready for use place one inch or more of beach sand on the wooden or concrete floor and then add about three inches of rice or other straw for litter. The sand will make cleaning easier.

Roosts

Make the roosts from 1 x 2 lumber. Nail each roost on the level to the side of the wall eight inches from the dropping board; each roost is spaced fourteen inches apart as shown on page 5, figure 2-R. Each bird will occupy a space of about twelve inches on the roost.

Dropping Boards

The dropping board can be made most satisfactorily from tongue and groove box lumber. Set this platform about two and a half feet from the ground, as shown on page 5, figure 2-d. Place the boards so that the cracks of the groove lumber are perpendicular to the back wall. This will make cleaning easier.

Nests

The nests can be made out of orange crates or boxes having a similar dimension. (Page 11, figure 11.) Nail a piece of three-inch batting or lath lumber on the lower part of opening to hold the nest material in place. Locate the nests in a convenient place in the poultry house. They may be placed twenty-four inches off the floor in a single row or in tiers as shown in page 5, figure 2-N.

Feeds and Feeding

Poultry feeds are now manufactured from the best materials by all feed milling concerns, and for that reason it is cheaper to purchase these prepared poultry feeds than to prepare the mixture at home.

The poultry feeds that come to Hawaii are from well known mainland manufacturers and are carried in stock by their local agents and retail grocery stores. Any will fill the needs of a poultry beginner. The precaution to take in buying the feed is to see that the contents of the sacks are not wormy. This condition is not the fault of the brand of feed, but rather its age. There are two methods of feeding layers; one is by the all mash system, and the other is a combination of scratch feed and mash. Both systems contain the necessary ingredients for egg production. The grain feed also known as scratch feed is made up of

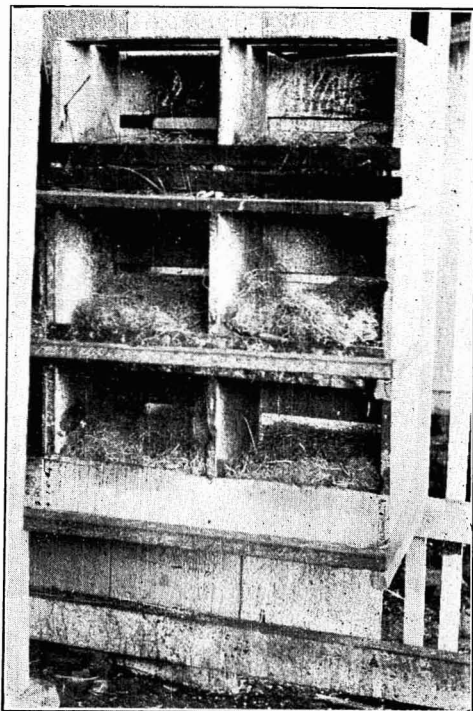

Fig. 11—Nests made from orange crates.
They are efficient and cheap.

two or more grains of cracked corn, wheat, kaffir corn, milo maize, buckwheat, oats and some sunflower seeds. The mash feed is largely a combination of wheat, bran, middlings, shorts, ground oats, corn meal, meat scrap and alfalfa meal. The all mash contains the grain and mash in milled form. If the all-mash feed is used place the feed in a hopper (see page 7, figure 5) so that the birds will have access to it all the time. A hen will consume about seven pounds of the all-mash feed per month.

When the scratch and mash feeds are used, place the mash in the hopper before the layers. As to the feeding of the grain ration, however, divide the amount required for the flock of layers into thirds, one-third to be fed in the morning and the other two-thirds in the later afternoon. The amount of feed needed by each hen in this grain-mash system is about three pounds scratch and three and a half pounds of mash per month per bird for the

Leghorns or Minorcas; for the utility breeds, such as the Barred Rocks and Rhode Island Reds, three and three-fifths pounds scratch and four pounds mash per bird per month. When feeding the grain place it in a feed trough instead of scattering it on the floor or ground.

Feed Containers

A mash hopper three feet long will be ample for a flock of twelve layers; six feet long for twenty-five; twelve feet long for fifty; and twenty-four feet long for one hundred. Not all birds will eat at the same time at the hopper. However, the feed trough for the scratch feed (page 7, figure 6) should double the length of the hopper if feeding is done from only one side. But if fed from two sides the dimensions for the mash hopper will be sufficient.

Store the mash and grain feed in a box or bin to keep them dry and away from mice, rats and insect pests.

Table Scraps

One of the strong points advanced in favor of a home flock is the using of table scraps which would otherwise go to waste. Bread crumbs, meats and vegetables may be chopped up in small pieces and fed to the birds in addition to their regular feed. Egg shells from the kitchen must be crushed before taking them to the poultry yard to prevent the layers from acquiring egg eating habits as they will if half shells are fed to them.

Green Feeds

Provide a daily supply of green feeds, such as lettuce, cabbage, sweet potato vines or alfalfa for the layers. A layer will consume about twelve pounds of green feed a year.

Minerals

Make a box about twenty-four inches long, four inches wide and six inches high. Divide into four compartments (page 14, figure 12) to hold medium sized bone, grit, charcoal and oyster shell. Place this near the mash hopper and let the birds help themselves. Each bird will use about two and a half pounds bone, two pounds grit, two and a half pounds of charcoal and four pounds of oyster shell in a year.

Water

Provide a supply of fresh drinking water for the flock daily. The container must be cleaned each day by scrubbing. Place the water fountain in a shady place (page 15, figure 14). A flock of ten layers will drink between one and a half to two quarts of water per day or from one-third to one-half pint per bird per day.

Changing Feed

When contemplating the change of one brand of feed to another or from the grain-mash to all-mash or vice versa, do it gradually. This may be accomplished by adding the new brand of grain or mash to the old in proportions of one-fourth, one-half and three-fourths at every three-day interval and until the new feed has replaced the old.

Incubating Eggs

The beginner may or may not be familiar with incubators that hatch eggs artificially. No attempt will be made to discuss this subject in this bulletin, but rather assist the beginner to get closer to nature by the use of broody hens.

Hatching Season

The hatching season is, in most parts of Hawaii, from December 15 to April 15. In cooler regions, like Waimea and Kula, the hatching period may begin in November. However, for a beginner it is very unlikely that he will get an early hatch with broody hens as they do not usually go broody so early.

Breeding Stock

Should a beginner desire to raise a breeding flock to produce hatching eggs he should keep one matured cockerel to twelve Leghorn or Minorca hens or one matured utility breed male to eight females. This number will give high fertility in most cases.

Care of the Hatching Eggs

Eggs intended for hatching should be of uniform shape, size and same shell texture. An egg weighing about two ounces is about the best size to use for hatching purposes. The eggs should be placed in a cool place and turned once a day while accumulating. Do not keep the eggs longer than seven days.

Inducing Hens to Set

Some hens will lay a few eggs and then become broody, while others lay for a long period before they desire to set. To induce a hen to get broody quickly have two nests containing ten or more false nest eggs each. The constant sight of these eggs will tend to make the hen go broody sooner.

To make the nest eggs knock off the small end of the egg so that the opening is about one inch in diameter. Pour out the content, wash the interior and fill with plaster of paris which has been previously moistened. As soon as the content is hardened it is ready for use. The egg shell may show the sign of a crack, but this does not matter.

Setting and Care of Broody Hen

When a hen shows signs of broodiness she will be ready to take a set of eggs for incubation. Secure another nest; place some newspapers at the bottom and then some straw. Then place

thirteen to fifteen eggs in the nest, depending on the size of the hen. Take hold of the hen gently and dust her for lice with sodium fluoride, see page 15 figure 13, then place her in the nest with the eggs and close the opening. Allow the hen to come out for her feed late each afternoon. This precaution is taken to prevent other hens from taking possession of the nest. However, if a large box is available and arranged with a door the broody hen may be placed in it with the nest, feed and water without daily attention. Keep a record when the eggs were set and figure the date of hatch due twenty-one days hence.

Provide scratch feed whole, corn, grit, green feed and water for the broody hen. Do not feed mash.

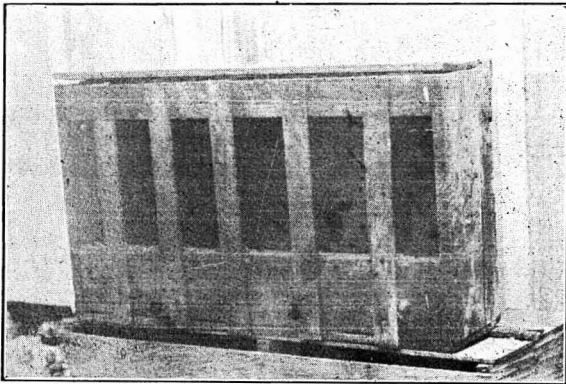

Fig. 12—A grit box made from box lumber and divided into compartments to hold grit, bones, charcoal and oyster shell.

Testing the Eggs

Hatching eggs are generally tested on the seventh and fourteenth day during the hatch. But for a beginner it would be safer if the eggs under the hen are tested on the fourteenth day. By this practice little trouble will be encountered in separating the infertile from the fertile eggs.

Egg candling outfits are made in different styles and material, but the cheapest and simplest is made from a paper shoe box as shown on page 16, figure 15. Make a circular hole $1\frac{1}{2}$ inches in diameter in the center at the bottom of the box. Make a slit at the top end to admit the electric light cord. If oil lamp is used a metal or wooden box should take the place of a paper shoe box and enlarge the opening at the top.

To use, place the light in the box and close the opening with the cover; this homemade apparatus is then ready for use. Candling is done at night for convenience, but can be done equally as well during the day by making the room dark or doing the work



Fig. 13—A convenient method of applying sodium fluoride powder. Insert, at upper right, showing method of holding the powder for application.

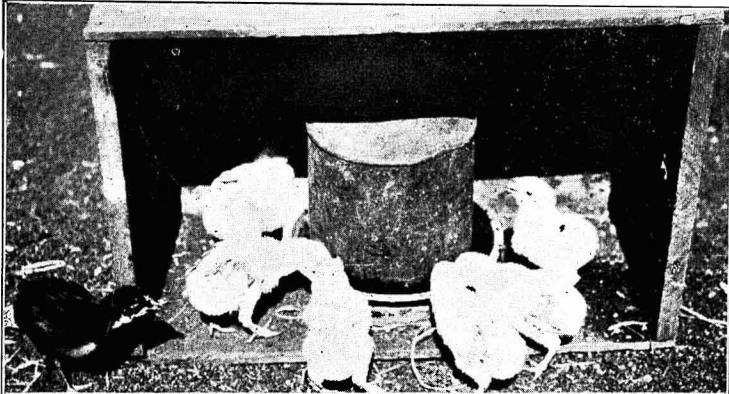

Fig. 14—A simple water fountain adapted for a small flock of adults or for the growing chicks. It is made from a gallon can and a deep pan. (Photograph courtesy Hawaii Experiment Station)

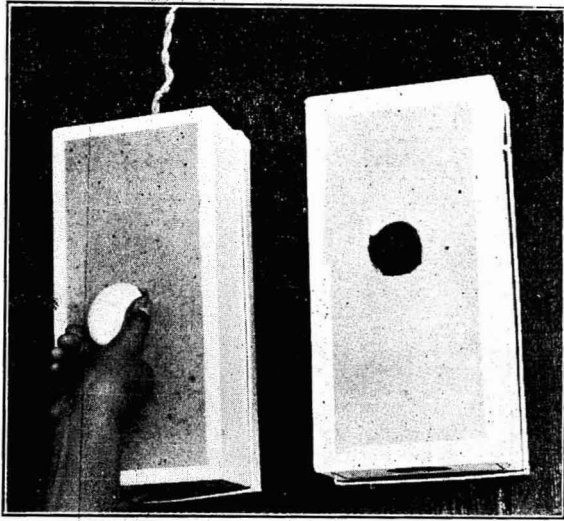

Fig. 15—Egg candling apparatus made from a shoe box (right); at left is shown how the egg is held for candling.

in a closed closet. Hold the eggs with the round end up and hold against the round opening as shown on page 16, figure 15. All fertile eggs, i.e., those that will develop into chicks, will assume a dark mass before the light; while those infertile ones, i.e., those with a germ and will not develop a chick, will appear clear, transparent or watery. The infertile eggs are removed from the nest. Do not turn in front of the opening.

Hatching Time

When the chicks are hatching under the hen place a piece of board over the opening of the nest. This will keep the chicks from falling out and getting chilled. Between nine and eleven chicks should hatch from a setting of thirteen and fifteen good hatching eggs respectively. Better results may be obtained if the fertility is high and the breakage is low.

Hatching time is a very thrilling moment for a beginner, but his curiosity must not be satisfied by looking into the nests or lifting the hen up to see what progress is made. Leave the hen alone until the hatch is completed the next day at least. Some hens will get roused and may crush the chicks during the moment of excitement.

When the hatch is completed place the hen and chicks in a large box or brooder run (page 19, figure 16). Feed the hen with scratch feed and water immediately; no feed is given the chicks until they are over forty-eight hours old.

Chick Feeds

Before the advent of commercial poultry feeds, stale bread, milk, boiled eggs and rolled oats formed the basis of home prepared feed for chicks. This combination has always proved to be a reliable feed. But now chick feeds have been brought up to such a high standard that, like the adult feeding, it is far cheaper to use prepared chick feed.

The commercial feeds for chicks are practically the same as for adult birds except that it is prepared in a more delicate form adapted to different ages. The grain ration is made up of fine, pin-head oats, fine cracked corn and fine cracked wheat. And the chick mash is a combination of yellow corn meal, rolled oats, wheat bran middlings and sifted meat scraps.

Chicks are not fed until they are forty-eight hours, or more, old. The reason for this is that each chick is naturally provided with the yolk to last at least two days. So by holding the feed back until then, the digestive organs of the chick will be given a chance to develop slowly. However, baby chick grit moistened with sour milk may be given after the first day. The grit plays the part of the teeth; it helps to grind the food into tiny pieces in the gizzard.

Feeding the Chicks

After the chicks are over forty-eight hours old place sour milk in an inverted glass jar and let the hen and chicks drink. Half an hour later place the chick starter feed or all-mash for chicks on a piece of black paper in order to teach the chicks to see the feed readily when the hen calls. For this purpose a piece of roofing paper 18 x 18 inches will serve. Here the new poultry raiser may be disappointed to see the hen scattering the feed with her claws ruthlessly. If this should happen do not be discouraged as this is the natural habit of a hen.

After the chicks have learned how to help themselves, after the second day, then the feed can be fed outside of the hen enclosure with no waste. The general practice is to feed the chicks with the starter scratch and mash five times each day with just enough feed at each time to keep the little chicks' appetites keen for the first two weeks.

At the beginning of the third week the developing chick scratch is fed four times a day, and the developing chick mash, sour milk and green feed placed before them all day. Bones, charcoal, oyster shell and grit must be supplied from the second week and throughout the growing period of the chicks. Place them in a box so that they will have access to them.

From the eighth week on the chicks will have the growing scratch three times a day and mash, or all mash.

There are four things which the beginner must observe in chick feeding. These are:

1. Feed milk and green feed as daily rations.
2. Do not change the milk from sour to sweet or vice versa.
3. Do not change one kind of feed to another suddenly.
4. Feed the chicks each day on time.

Weaning the Chicks

The usual period which the hen-brooded chicks are weaned from the hen is six weeks. But as a precaution for the beginner it would be better to allow the chicks to run with the mother until they wean themselves. In the meantime—between the tenth and twelfth week—segregate the cockerels from the pullets. This practice will enable the future layers to develop faster without the annoyance of the male birds. The growing birds should weigh between $1\frac{1}{2}$ to two pounds at this age depending on the breed.

Fattening Cockerels

The cockerels that are not desired for future breeders may be penned up in a coop and fattened with a quick fattening ration or placed in another yard for future consumption and fed with a slow fattening ration.

A simple fattening crate can be made from a box about 2 x 3 feet and $1\frac{1}{2}$ feet high. Knock the bottom and one side off and replace the bottom with laths spaced $1\frac{3}{4}$ inches apart. The lath bottom will keep the floor clean as it will allow the droppings to fall through. The laths for the side are nailed vertically and spaced $1\frac{3}{4}$ inches apart. The feeding trough, made from two pieces of 1 x 3 lumber into a V-shape, is located outside of the crate. The crate is set up on legs about $2\frac{1}{2}$ feet from the ground. From eight to twelve broilers or six hens can be accommodated in a crate of the size mentioned.

A quick fattening ration may be compounded by mixing with three parts corn meal, two parts low grade flour, and one part shorts. Add enough buttermilk or sour milk to mixture so that the mass will be drippy and yet not sloppy. Starve the birds one day and then feed the fresh mixture to the birds in troughs. Allow the birds to eat thirty minutes and then remove the feed. Feed again in the afternoon. After one or two feedings the exact amount of feed per feeding can be determined. For the beginner start with one cup of mixed feed with sour milk. This will be sufficient for five or six birds of the broiler size.

The fattening period is fourteen days with two feedings daily. At the end of this time birds must be disposed of, and no attempt should be made to continue to feed the birds as they will not make further gains economically.

A slow fattening ration for growing birds, to be raised in the open, is made from $8\frac{1}{2}$ parts cracked corn and $1\frac{1}{2}$ parts beef scrap. Place the feeds in separate hoppers and let the birds have access to them. Grit, charcoal, oyster shell and bones should

be before them also. The time required to finish birds by this slow ration is from four to six weeks.

Feed for Pullets

The amount of feed necessary to develop a pullet to six months of age from a chick ranges from about twenty-four pounds for egg breeds and about twenty-seven pounds for utility breeds. Each chick will consume about three-fourths of a pound of oyster shell, one-half pound charcoal and two and a half pounds of grit up to the age of six months.

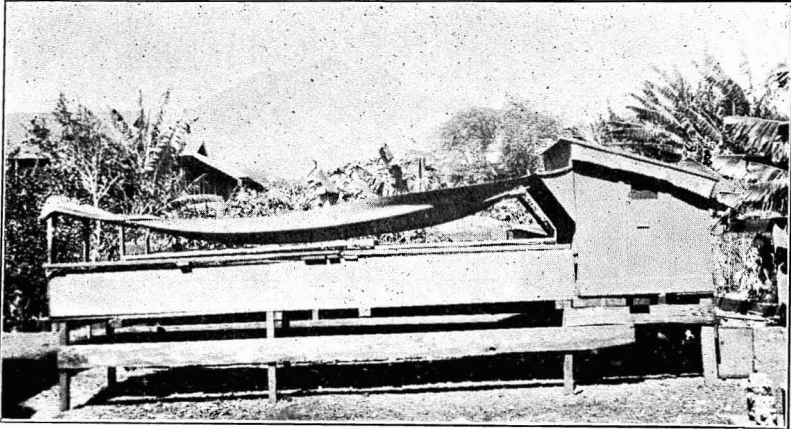

Fig. 16—A simple combination brooder and chick run for successful chick raising in Hawaii for either natural or artificial brooding. (Photograph courtesy Hawaii Experiment Station)

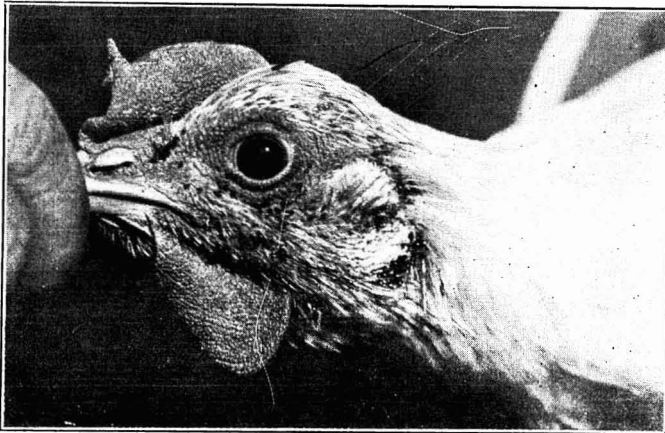

Fig. 17—An adult hen infested with sticktight fleas about the head, face, earlobes and wattles. (Photograph courtesy Hawaii Experiment Station)

Ailments of Chicks

There are certain ailments which may appear in chicks. Should they come, be prepared to find the cause based on the accompanying table. The necessary step to take when there is a dead chick is to destroy it by burning and not leave it about the yard. The following is a brief list of chick ailments:

Signs	Probable Causes	Remedies
Bowels loose, watery.	Chilling, poor feed.	Correct feedings; if chicks chilled, no remedy.
Crop filled with gas. Crop hard.	Sour crop, inedible food. <i>Crop bound</i>	Squeeze out air; feed carbonate of soda in water, 1 tsp.— $\frac{1}{2}$ glass.
Droppings bloody.	Crop bound. — <i>Coccidiosis</i>	Feed olive oil and massage. Clean quarters. ↗
Droppings white, loose.	<i>Coccidiosis.</i> <i>Diarrhoea</i>	Clean quarters. Feed sour milk.
Hard breathing, mouth open.	<i>Diarrhoea.</i> Cold in lungs.	Rub camphorated oil on affected parts; keep chick warm; feed warm milk.
Swollen or closed eyes.	Cold.	Press out mucous from nose, bathe affected parts with boric acid.
Swollen head.	Roup.	Bathe head with warm boric acid; press out mucous from mouth or nose.
Warts on head and Comb.	Chicken pox.	Wash affected parts with warm water, paint with iodine and cover with carbolated vaseline.
Weak legs	Worms, faulty feeding.	Feed codliver oil—one cup to 25 lbs. mash, mix thoroughly.

MANAGEMENT OF THE FLOCK

How to Treat New Birds

When adult birds are introduced into the new poultry yard take all necessary precaution to prevent the introduction of diseases and poultry pests. First dust the bird with sodium fluoride powder which can be obtained from any drug store. To apply hold the bird by the legs and place the body on a table or box. With the thumb and index finger grasp some of the powder and insert at the base of the feathers on the head, neck, breast, back, below the vent, base of tail, both thighs, sides under the wings and on each wing.

The next step is to wash the legs and beak of each bird with a disinfectant. Use three teaspoons (3%) camphenol in one quart of water. Wash the beak of each bird with a cloth moistened with the solution, then wash the legs. Then finally examine the head, face and wattles of each fowl for sticktight fleas, page 17, figure 17. If this pest is present secure some No. 5 lubricating oil, use a sponge saturated with this oil and go over the affected parts. The fleas will die shortly after the oil comes in contact with its body. This same treatment applies to chicks also if they are affected with fleas.

Care of Imported Birds

Many laying and breeding birds are imported into Hawaii annually. If adult birds are obtained from this source first treat their legs and beak, for disease carrying germs, for lice on the bodies in accordance to the instruction under the subject of "How to Treat New Birds." For feed give an abundance of moist wheat bran and green feed for the first three days, after which the regular feed may be given.

Care of the Laying Flock

The adult birds respond to good care and if everything is provided for the flock's comfort good results will be obtained.

Providing Shade

One of the secrets of successful poultry keeping is to make the layers comfortable, especially during the warm months. This is particularly true under Hawaiian conditions. Shrubs in the poultry yard which furnish natural shade are a valuable asset to those who have them. But in poultry yards of less fortunate circumstance in this respect a framework three feet high constructed with 2" x 4" and 1" x 3" lumber and covered at the top with coconut leaves will serve as the best artificial shade for the fowls in Hawaii. It is efficient, practical and economical.

Laying Period

One of the fascinating things in the home poultry keeping is to estimate the daily production of the birds during the absence of the poultry raiser from his flock, and see how close his guess was to the actual result. Keep a daily egg record by month.

Egg laying, like other activities, has a definite period during the year for heavy and light production. In Hawaii the heavy laying season is during January, February, March and April, while July, August and October production is at the lowest ebb.

For a home flock the per cent of production by the month is approximately as follows: January, 63% ; February, 64% ; March, 69% ; April, 61% ; May, 56% ; June, 51% ; July, 45% ; August, 44% ; September, 34% ; October, 25% ; November, 40% ; December, 51%.

Replacing Layers

The pullet makes her best egg record during her first year of laying and then gradually lays fewer eggs each succeeding year. That is the reason why the White Leghorn pullets are sold at the end of the first laying season in most commercial egg farms. For the beginner, however, this practice need not be followed until after the end of the third laying season, or longer if they are used as breeders in the case of White Leghorns or Black Minorcas. The utility breeds become poor layers after the end of the second laying season. This is because they tend to put on flesh and fat each succeeding year. Unless these birds are wanted for a purpose they should be disposed of and new ones put in their places.

Keep Roosting Quarters Clean

One of the things which the home flock owner must observe is consideration of his neighbors. Every effort must be made to eliminate the odor from the dropping board if the home flock is large. To do this remove the manure each morning; place it in a box and cover it with fine soil in amount equal to one-third the volume of the manure. This will help reduce the annoying odor to the minimum.

Another method of eliminating the odor is to scatter slacked lime on the manure.

Disposing of Litter and Manure

If the backyard is a large one where vegetables are grown in conjunction with poultry it is an easy matter to dispose of the accumulated manure. Each week's supply can be placed on the bed and gradually worked into the soil for the next crop.

The litter is a bulky article for a backyard poultry raiser to handle if the area is limited. Unless he is favored with a large backyard, where he could dispose of it by placing it in a pit and using it as a valuable fertilizer for flower beds later, the litter must be disposed of by burning.

Poultry manure is a valuable fertilizer. It is sold at forty cents per sack in Honolulu. It is likely that the neighbors and flower gardeners will be glad to take the litter away at the time of buying the manure.

Broody Hens

When a layer is found in the nest late in the afternoon it is very likely she has gone broody. Broodiness is a natural thing

with hens, especially with the utility fowls, but less pronounced with the egg breeds.

As soon as a bird is discovered in the nest after dark take her out, if she is not desired for a setting, and place her in a coop or box with a slat bottom. Provide feed and water. In the course of four days the bird will forget about brooding and shortly go back to laying again.

To keep a simple record of all broody hens place a spiral colored legband on the leg of each bird every time she goes broody. A layer that gets broody too often is a poor layer and an unprofitable one. Eliminate the broody ones especially if the flock is intended for breeding purposes the following year.

Culling

Culling in a home flock has to do with removing all unprofitable layers, breeders and growing stock primarily. This is an interesting part of the poultry venture and it requires much experience. But for the present the beginner will do well to keep his eyes on birds that have dry, powdery, shrivelled combs. Catch such birds and examine the abdomens and vent. If they are hard, contracted and coarse, it is safe to discard such birds because they do not lay enough eggs to pay even for food.

Ailments of Adult Birds

The adult fowl is subjected to a number of ailments. A detailed description of poultry diseases is treated in a separate bulletin, Agricultural Studies No. 11. Among those that are most likely to be encountered by the beginner will be colds (roup), intestinal and eye-worms, baggy abdomen and lameness.

Colds with watery nostrils can be remedied by removing the mucous and washing with boric acid before applying a drop of camphorated oil in the nostrils. Roup, which is an advance case of cold is indicated by a swollen face, and is hard to cure. Unless it is a valuable bird it is not worth treating because much time is required and the improvement is slow.

Intestinal worms may be overcome with worm medicine as per direction of each manufacturer.

Eye-worms become serious pests and a menace to the health and eye sight of the bird; when the eyes of the fowl become watery remove the worms by pressing them from under the third or membranous eyelid. A little vaseline placed on each eye after the work will soothe the pain.

Baggy abdomen is due to excess fat or tumor in two year old hens, especially of the utility breeds. When this ailment appears in the egg breeds the cause is due to a breakdown caused by heavy laying.

Lameness may be due to algaroba (kiawe) thorns, bumble-foot, paralysis, worms or some internal disease like tuberculosis. Lamé birds should be examined for the external causes. If found,

remove the cause. Iodine may be painted on swollen parts. When there is no visible sign give the affected bird a dose of epsom salts (one tablespoon to one-half cup water) and place the bird in a warm place.

Preserving Eggs

Surplus eggs from the flock may either be sold or preserved for future use. The kind of eggs suitable for the purpose must be infertile (eggs produced **without** the presence of the rooster with the layers), clean, uncracked, hard-shelled. Eggs that are soiled, thin-shelled and cracked should be used immediately and never kept for preserving.

One of the simplest methods of preserving surplus eggs is by the use of water-glass. This is a pale yellow, sirup liquid which can be secured from any drug store for about twenty cents a pint.

Secure a crock or glass jar large enough to hold about twelve quarts of water. Clean the container thoroughly. Boil five quarts of water and allow it to cool overnight, then measure nine pints and place in the container. Add the one pint of water glass and mix thoroughly. Place the crock in a cool place and the liquid is ready for use.

Add the clean, freshly laid eggs in daily and take care not to crack any. The capacity for this amount of water glass is eight dozen eggs. The main precaution to take in using this method of preserving is to see that the top layer of eggs when the container is almost filled, is covered with at least two inches of the liquid. Cover the opening with a board and take out the eggs as needed.

Marketing

Many poultry dealers of the Mainland and Hawaii were once backyard poultry raisers. Their present business had its early beginning in the selling of a few extra dozen of eggs or a few extra chickens to the neighbors or friends. These men were encouraged to develop the backyard enterprise into a real business as a result of constant demands for their products. They have succeeded because they emphasized quality. When selling eggs they selected them according to size, shape and color. For a package they used an attractive carton. In other words, the best goes to the customers and the others are used at home.

When selling poultry for meat keep this in mind: Do not sell a defective bird, such as one with a blind eye, broken wing, crooked leg or crooked breast bone, to a customer. Every effort must be made to make the bird look as attractive as possible in order to induce the neighbor to buy it. This is good salesmanship. If the birds are fattened with the use of milk be sure to emphasize this point when selling to a customer.